

**8 Roof vent:**  
Insert vent socket into frame and align. The pipe should extend inwards.

**9 Connection to masonry / chimney:**  
Building must have zinc or lead flashing and bitumen-compatible, non-hardening plastic-sealant.

**Translucent sections:** Use only our compatible *guttanit*<sup>®</sup>/*guttapral*<sup>®</sup>/*gutta do it*<sup>®</sup> corrugated transparent sheets. Corrugated transparent sheets made of PVC must be predrilled.

**Storage of sheets prior to use:**  
Store in a dry and clean place prior to use. The product may deteriorate when kept stacked in humid or wet conditions with inadequate ventilation; no liability is accepted for such damage.

**Safety instructions**

- Due to the specific properties of bitumen (hardens when cold), the corrugated sheets / accessories must be handled with care at temperatures below 10 °C.
- In accordance with DIN 274 **do not walk on the bituminous sheets unless a weight-distributing running board has been placed on top.**
- Permanent roof-access routes and duckboards must be provided for installations and devices which require regular maintenance (e.g. chimneys, ventilators) and which can only be reached across roof surfaces.
- **As in all building projects, the local building regulations must be complied with. Ventilation of the roof space must be guaranteed in accordance with DIN 4108.**
- For all special roofing functions, such as breeding barns, it is recommended that you contact the *gutta* technical consultants.
- Our recommendations do not relieve customers of their own responsibility to check that the product is suitable and is being used in the right place. If in doubt, please contact our *gutta* technical consultants.

We reserve the right to make technical changes.

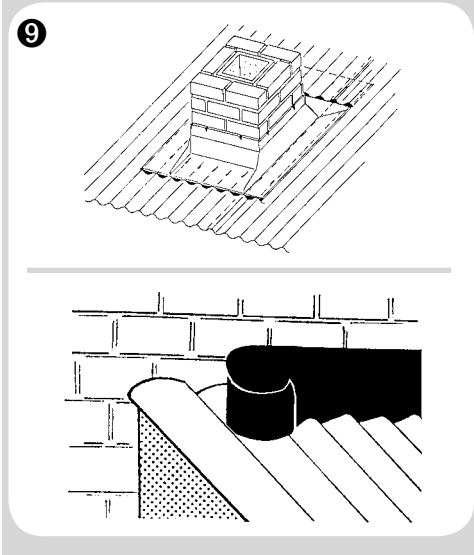

The manufacturer provides a 15 year warranty in accordance to the following warranty terms on condition that the genuine *gutta* products are used and the installation instructions are followed.

The *gutta werke* guarantees its *guttanit*<sup>®</sup>/*guttapral*<sup>®</sup>/*gutta do it*<sup>®</sup> bitumen corrugated sheets for roofs and walls within the following scope and in accordance to the following terms:

**Extent of warranty: Water permeability**  
For justifiable warranty claims due to water permeability within **15 years** from the date of the sales slip the *gutta werke* will replace all the materials of the sheets and the accessories.

The warranty is not extended to the cover replacement costs and does not cover damage to corrugated bitumen sheets that was caused by gale force wind, hail, lightning, or by the fault of someone other than the warrantor.

**Terms of warranty**  
The aforementioned right to claim under warranty may only be asserted if the following conditions have been met:

- the original receipt with purchase date and purchase quantity must be submitted
- the local and national building regulations and statutory ordinances must be observed

- the installation instructions (included in each package of nails) were followed
- once damage was determined, the notice of damage form was immediately requested, filled out, and sent back to the issuer of the invoice. Please request claim notification in your respective language.
- no work included in the scope of this warranty work was performed without the approval of the *gutta werke*.
- measures for minimizing damage were implemented.

Within 4 weeks of receiving the notice of loss and in compliance with the above terms, the *gutta werke* manufacturers for its part, depending on scope of damage, is obliged to send an inspector to assess the damage or to promptly make good the damage. Repairs or replacement work performed under warranty neither extends the period of warranty nor begins a new period of warranty.

Warranties provided by the vendor to the final customer based on



**gutta**  
www.gutta.com

## FIXING INSTRUCTIONS

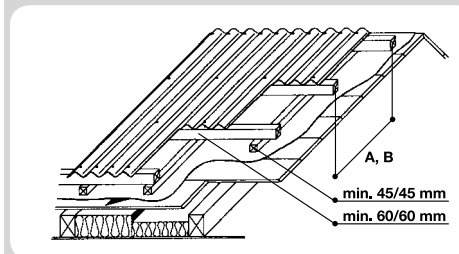
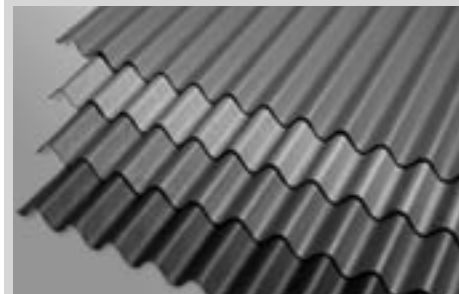

- 1 Requirements:**
1. Genuine *gutta* products
  2. Support laths 60 x 60 mm
  3. Counter laths min. 45 x 45 mm
  4. Minimum roof pitch - 7°
  5. Planning permission (depending on local regulations)



*guttanit*<sup>®</sup> - / *guttapral*<sup>®</sup> - / *gutta do it*<sup>®</sup> - corrugated bitumen sheets

Type	cm	Area covered m <sup>2</sup>			Wave	
		gross	net K1	K2	numb.	size
<i>guttanit</i> <sup>®</sup>	200 x 106	2,12	1,82	1,63	14	76/30
<i>guttapral</i> <sup>®</sup>	200 x 95	1,90	1,58	1,37	10	95/31
<i>gutta do it</i> <sup>®</sup>	200 x 87	1,74	1,50	1,34	14	62/28

**Example for a 2 x (5 x 10) m gable roof (100 m<sup>2</sup>):**

500 m altitude, pitch 20° (36,4 %) for type B (46 cm gap between support laths)

1. 100 m<sup>2</sup>/1.82 m<sup>2</sup> net = 55 *guttanit*<sup>®</sup> corrugated bituminous sheets  
50 x approx. 28 nails = 1,540 *guttanit*<sup>®</sup> S nails

2. 10 m/1 m net = 10 *guttanit*<sup>®</sup> ridge cap-gable angles  
10 x (2 x 13) nails = 260 *guttanit*<sup>®</sup> S nails

**Total: 1,800 *guttanit*<sup>®</sup> S nails**

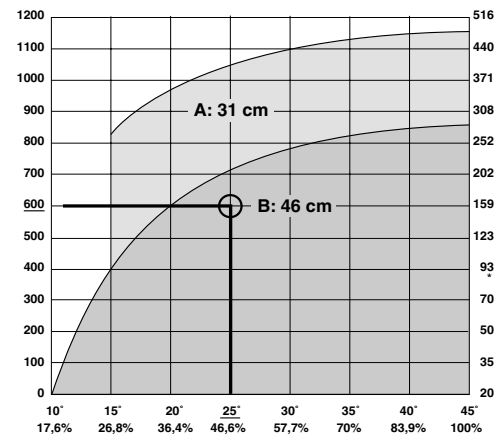

### Location of building / roof pitches

m altitude kg/m<sup>2</sup>

Roof pitch in degrees and percent  
\* The minimum figure specified by SIA (Swiss Society of Engineers and Architects) for Switzerland (even at low altitudes) is 90 kg / m<sup>2</sup>.

**Example:**  
Area to be covered: 600 m altitude. Roof pitch: 25° (46.6%)  
What lath gap is required? 46 cm

**Counter lath gaps**  
Counter lath gaps are determined according to SIA standards and depend on location of building (altitude), roof pitch, wind pressure and snow load (kg/m<sup>2</sup>).

**Wood impregnation**  
Before laying the sheets, make sure that the timber structure / timber sub-roof has been treated against insects and fungi with a wood preservative.

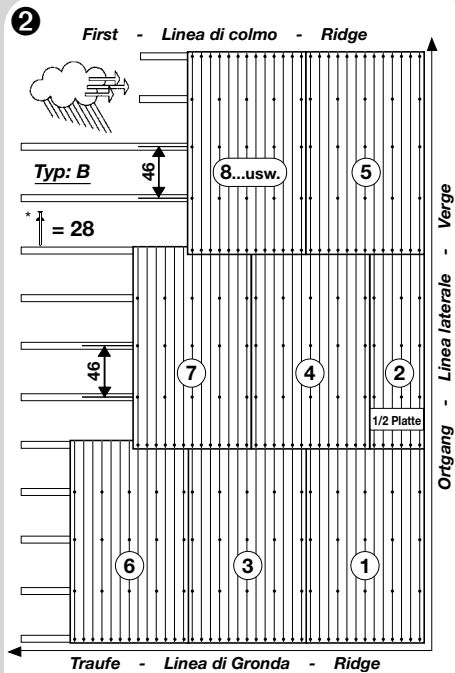

### Underlay sheeting:

In order to collect existing condensation water, underlay sheeting which is permeable to condensation water is necessary. It must be watertight at the ridge and not drain off into the gutter (gutta-sheet). The bituminous parts may cause the condensation water to turn light brown in colour

### 2 Laying materials

To lay **guttanit® / guttapra® / gutta do it® corrugated bituminous sheets** you need a saw, a hammer, a plumb line and **guttanit® S nails**.

**Laying pattern:** Against the main wind direction from verge to verge, from eaves to ridge.

### Offset laying

Bracing cover. **Offset by ½ sheet width** to avoid the need for trimming corners. Saw sheet in half with greased saw.

\* When using **guttanit®** and **gutta do it®** corrugated bituminous sheets, nails are generally nailed into the middle of every third offset corrugation.

When using **guttapra®** corrugated bituminous sheets, nails are generally nailed into the middle of every second offset corrugation.

Wall siding: **guttanit® / guttapra® / gutta do it®** corrugated bituminous sheets are also suitable for wall siding. Make sure that the bottom edge of the sheets is at least 20 cm from the ground. The same instructions as for the roofing apply to all overlaps. Lath gaps: max. 62 cm.

### Overlapping

condition	with	lateral overlap	longitudinal overlap
K1	snow load areas	1 wave	min. 15 cm
K2	heavy rainfall areas	2 waves	min. 20 cm

### 3 Fixing materials

For fixing **guttanit® / guttapra® / gutta do it® corrugated bituminous sheets** use only the hot-dip galvanized guttanit® S countersunk-head nails with PE round-head washer.

**Nailing:** Tighten plumb line. Fix sheet, attach. Check seating of sheet, perform final nailing. Nail / secure in perpendicular position on crest of corrugation. Make sure that each sheet is tightly nailed.

### Attention!

Please nail the overlap of the outer corrugation at an angle (see figure). This will provide a better seal at the edge of the sheet. Stresses caused by nailing straight could cause the edge of the sheet to lift.

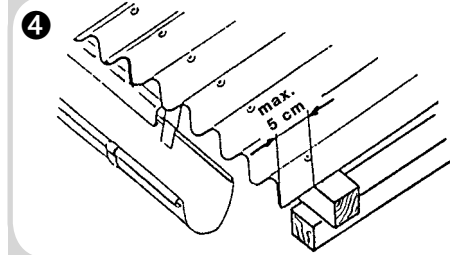
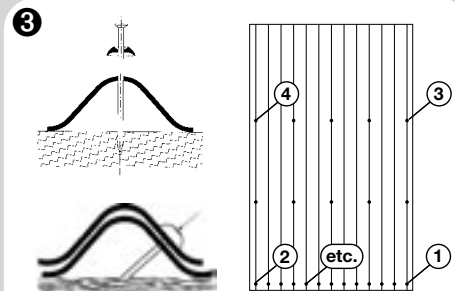

### 4 Eaves / ridge lateral and longitudinal overlap

The free overlap must not **exceed 5 cm** at the eaves. Nail in nails close to longitudinal overlaps and on the crest of each corrugation at the eaves. To prevent the **guttanit® - / guttapra® - / gutta do it®** corrugated bituminous sheets from warping, nails should be nailed perpendicular to the pitch of the roof. Line out before nailing. To avoid changing the cover width when nailing, first nail the crests of the first and second-to-last corrugations and then nail the ones in between.

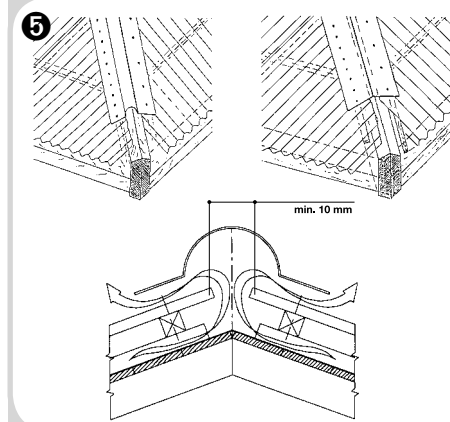

### 5 Ridge / hip covering with ridge cap / gable angle:

The elastic ridge cap or gable angle is suitable for any roof slope. An overlap of at least 10 cm must be ensured. Nails are to be nailed in on each corrugation crest. Corrugated sheets must end at least **5 cm** below the ridge crown line.

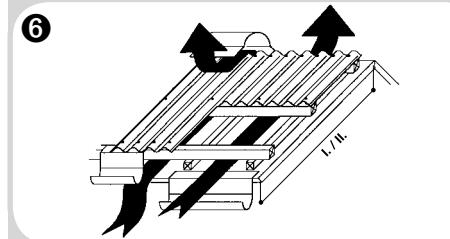

### 6 Ventilation

To prevent condensation and heat build-up, make sure that the **guttanit® - / guttapra® / gutta do it®** corrugated bituminous sheets are sufficiently ventilated, including from behind, in accordance with **DIN 4108:**

- I. Length of side of roof up to 10 m:**  
Ventilation inlet - 200 cm<sup>2</sup>/running m  
Ventilation outlet - 100 cm<sup>2</sup>/running m
- II. Length of side of roof more than 10 m:**  
Ventilation inlet - 2.000 cm<sup>2</sup>/100 m<sup>2</sup> roof area  
Ventilation outlet - ¼ of the ventilation inlet

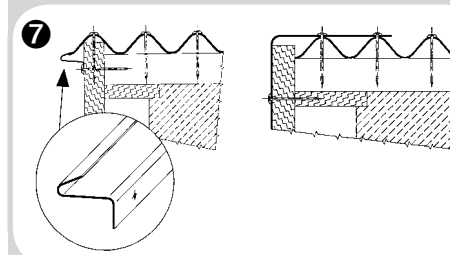

### Genuine gutta accessories

**7 Verge:** Use a verge profile or gable angle. **The last corrugation crest must rest on the verge lath.**

**Skylight:** First lay corrugated bituminous sheets. Using a pick blade, cut the corrugated sheets to fit the intended ventilation element; then nail cover frame. Separate laying instructions.